

Installation and Usage Manual



Intelligent Under Cabinet
3-Temperature UV Touch Control
Water Dispenser

LS500398

Installation and Usage Instructions

Touch-tap

LS500398

Touch faucet panel & LCD display

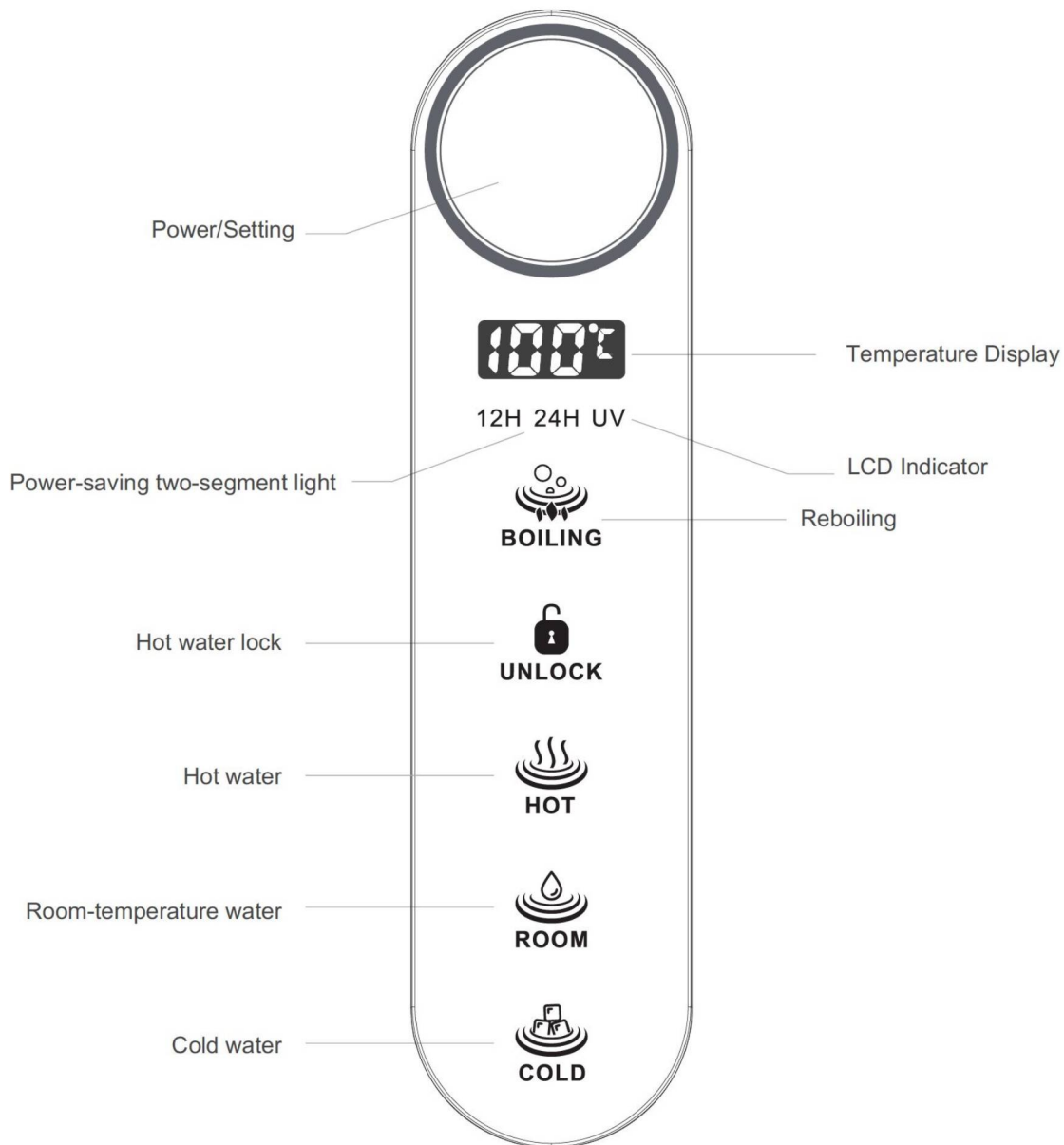

Installation and Usage Instructions

Important Notice



Warnings!

Please follow the instructions carefully for safety. Otherwise, fire, explosion or electric shock may occur and possession and people might suffer.

Important Information

Installation Instructions

1. Please read this manual thoroughly before using your water dispenser for the first time.
2. This manual contains important information on the installation, usage and maintenance of your water dispenser.
3. The manufacturer is not responsible for problems caused by ignoring the safety and cautionary instructions on this machine.
4. Electrical safety is guaranteed only when the grounding system of your house complies with the relevant local regulations. (Do not use extension cords.)
5. When the power cord is damaged, it should be replaced by the manufacturer's maintenance staff or relevant qualified personnel to avoid danger.
6. The product should be placed appropriately so that the plug is located in a place that is easily accessible, and the power supply can be cut off immediately in the event of an accident.
7. Do not move the unit horizontally or upside down to avoid potential damage.
8. The product should be connected to water source with the RO pipe in product accessories.

Children safety

1. This product should not be allowed to the elderly, infirm, children in the absence of supervision of the situation.
2. The hot water of this product is kept above 91 Celsius degrees. Be careful not to allow children to operate this product.

User Instructions

1. Do not spill water on the product as it may damage electrical components or cause an electric shock.
2. Do not use chemical solvents, strong acid or alkali cleansers on the panel.
3. Do not place heavy objects on top of the product as it may cause the product to deform and malfunction.
4. Do not place gasoline or other flammable gases or liquids near the water dispenser or other equipment.
5. Do not repair or replace any parts of the water dispenser or attempt to do so yourself.

Precautions on the use of the power cord

1. The product has to use a dedicated circuit, i.e., a single outlet providing power to one appliance, without other outlets or branch circuits.
2. Do not overload the wall outlet. Loose or damaged outlets and extension cords, frayed power cords, damaged or cracked cord insulation, etc., can be hazardous and may cause electric shock or fire.
3. Please check the power supply of this product regularly. If there is any damage or deterioration, please remove the cord, suspend the use of this product, and ask the authorized manufacturer to replace the parts properly.
4. Do not use the wire improperly. Do not twist, kink, pinch, or do anything that might damage the cord.

Grounding Instructions

1. This product must be grounded. In the event of a malfunction, grounding provides a means of minimizing resistance to current flow and reduces the likelihood of an electrical shock. This product is equipped with a grounding plug cord.
2. This plug must be plugged into an appropriate outlet that is installed and grounded in accordance with all local codes.
3. If you are unsure whether the product is properly grounded, have a qualified electrician and service representative accompany you to inspect the product. Do not modify the plug supplied with the product. If the plug does not fit the outlet, have a qualified electrician install a suitable outlet.

Installation Instructions



Warnings!

Please have a proper electrician or technician for any electrical and plumbing work required to install the product.

Step I Ready the opening

1. Put the water dispenser as close as possible to the water source for connection.

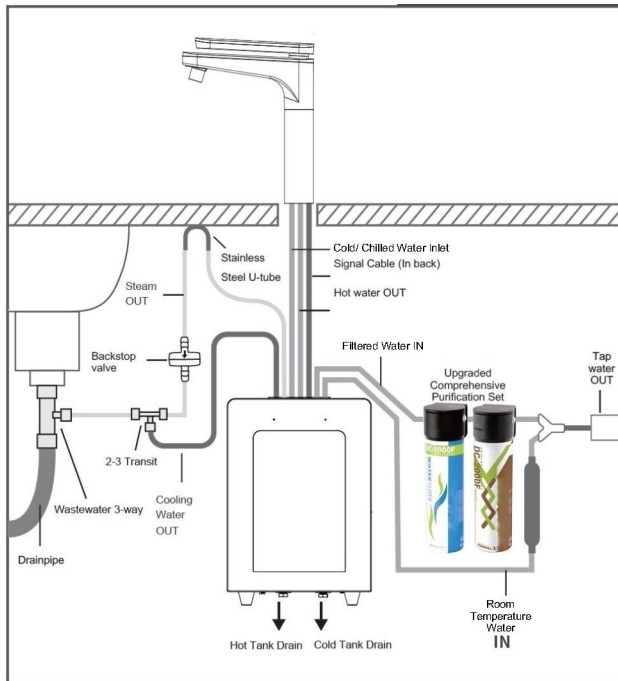
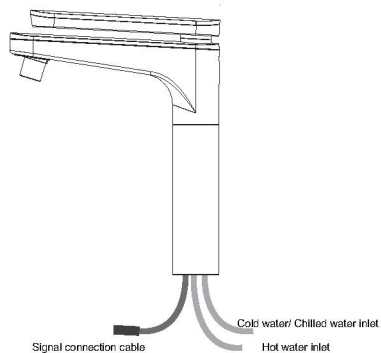

Installation Instructions Diagram

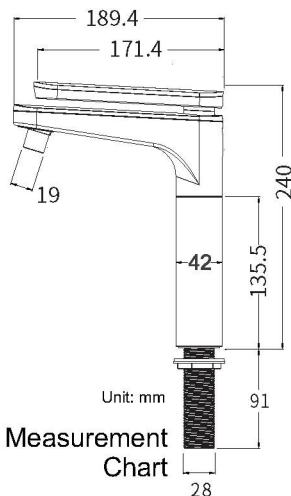

Measurement Chart



Warnings!

If an extension cord is required for this product, please use a separate extension cord with BSMI certification of 15A or above.

Step II Ready the cord and turn on the power

1. According to the user manual, this products requires power source with proper frequency and a separate, properly grounded branch circuit.
2. The power plug must be located in a visible place, at a distance of no more than one meter from the water dispenser.
3. The power plug must be grounded properly. The same outlet cannot be connected to other appliances with a double adapter or similar plug.

Step III Put in the water dispenser

1. Please adjust the height and balance of all parts before installing the water dispenser.
2. Please place the dispenser into the cabinet opening carefully and make sure the water inlet and drain hoses are not twisted or damaged.



Warnings!

When connecting or extending the pipe, please make sure that the pipe is not knotted. (The radius of turning should be larger than 40 mm).

Installation Instructions

Step IV Water supply determination

1. The operation pressure of water dispenser is (1-3kg/cm²).
2. Please purchase an additional booster if the water pressure is lower than (1kg/cm²), or a PRV, if the water pressure is higher than (3kg/cm²).
3. Keep the total length of water inlet pipe within 3m and the pipe itself roughly straight to avoid water supply error caused by lowered water pressure.
4. The inlet pipe can only be connected to filtered drinking water.
5. Keep the inlet pipe away from fire, explosives, and chemicals.

Step V Installation of input pipe

1. Connect the inlet pipe to the outlet of filter with 1/4 inch RO pipe.
2. Please use the proper switch for connection and use a waterstopper to avoid leakage when connecting.
3. The steam outlet should be installed in this order: steam outlet -> 1/4 silicon pipe -> stainless U-pipe (placed at least 20 cm above main unit) -> 1/4 silicon pipe -> backstop valve -> 3-way water drainpipe -> sink drainpipe (see the Instructions).

Non-pressure Water Tank

Outlook

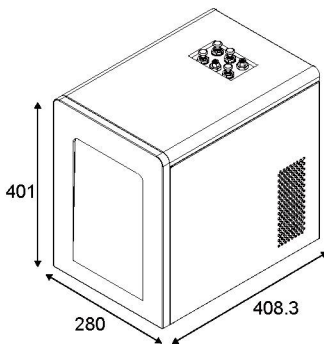

Unit: mm

Top Lid

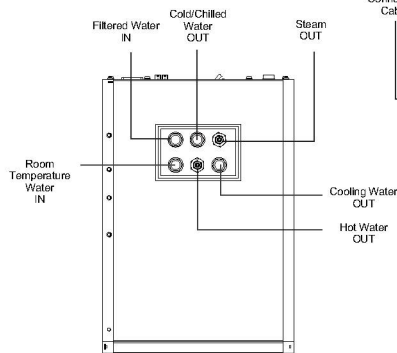

Back Board

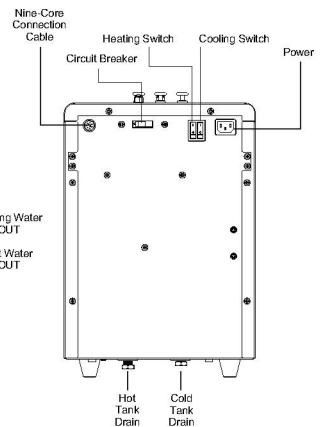

Warnings!

Please make sure that the inlet pipe is neither twisted, overbent, or leaking.
Please use filter provided by proper source to avoid malfunction and lowered water quality.

Step VI Final Installation

1. Use a wrench to make sure that the water hose is tight.
2. Plug the power cord into a grounded outlet, turn on the front panel, and turn on the leakage interrupter. Switch the tap on, and the water dispenser will run automatically.
3. The water dispenser will run automatically after installation. Once the water inlet is complete you can check the operation and see if there are any leaks.
4. During the first use of the machine, there might be some air in the pipes that chokes back water. If so, please turn on the faucet and let the water run until the problem is solved.



Warnings!

When heated, it is normal if the water expands due to heat and drip out from the tap. Please feel free to use.

- Startup**
1. The first water produced after installation may contain impurities and odors from the water supply pipe or the water tank.
 2. Missing hot water (approx. 3L) / chilled water (approx. 2.5L) and clean water (approx. 1.5L) produced for the first time after the dispenser is installed.
 3. After the initial installation of the water dispenser, please allow the dispenser to operate normally for more than 30 minutes and the temperature should reach 91 ° or above before consuming the water.
 4. If the dispenser is not in use for a long period of time, please turn off the power and water supply.
 5. Press and hold the ON/OFF key for 5 seconds to shut down the faucet.

- Operating Instructions**
1. To get cold water, press the "Cold Water" button and the cold water will flow continuously. When finished, press the "Cold Water" button again to stop.
 2. To get chilled water, press the "Ice Water" button and the chilled water will come out continuously. When finished, press the "Chilled Water" button again to stop.
 3. To get hot water, first press the "Hot Water Lock" button for 1 second. After the beep, press the "Hot Water Button" and the hot water will come out continuously. When finished, press the "Hot Water Button" button again to stop.
 4. To boil the water, press the "Reboiling" button. Operation will stop automatically once the water has been heated to 100°C.
 5. To reduce electricity consumption, press the "Power/Setting" button. When the light reaches the desired power saving time (12H, 24H), it will start to execute the time set for power saving, and the power indicator light will be on green at this time.

Note: "24H Power Saving" means that the power saving will continue until it is canceled manually.

When cleaning the touch tap: Do not use chemical solvents, strong acids, strong alkali cleaners on panel.



Warnings!

Keep children and elder people away from this Water Dispenser to avoid scalding. Avoid direct contact with the cup when obtaining hot water to avoid scalding. Do not use cups that are too narrow or shallow to avoid hot water spillage.

Specifications

Model LS500398

Tap Intellectual touch-control

Power Rate Hot: 750W(+20%/-10%); Cold: 130W(+20%/-10%)

Volume Hot water: 3L; Chilled water: 2.5L; Cold water: From filter

Inlet Pipe Diameter 1/4" (2-way pipe)

Materials Tap: PC; Inner pot: SUS304 stainless steel; Inner pipes:
Food-safe silicon, SUS304 stainless steel

Size Water dispenser: 408*280*401mm; Tap: 189.4*240mm

Safety Device Leakage proof for all series

Voltage 110-220V. Independent power source required.

Troubleshooting

*Please check the following table to see if the problem can be solved before contacting professionals.

Problem	Possible Reasons	Solutions
Unable to start the water dispenser.	<ol style="list-style-type: none"> 1. Power cord is not connected properly. 2. Water dispenser leakage breaker tripped or fuse blown 3. Indoor fuse blown, circuit breaker tripped, power shortage. 	<ol style="list-style-type: none"> 1. Check the power connection. 2. There might be an electricity leakage. Please unplug the water dispenser and turn off water source, then contact with maintenance personnel. 3. Do not overload the fuse. 4. Hire an technician if there is a circuit overloading.
The Water Shortage Indicator shows "--"	<ol style="list-style-type: none"> 1. Water shortage. 2. Water supply pipe twisted. 3. Filter blocked. 4. The water supply has not be restored after taking out too much water in a short time. 	<ol style="list-style-type: none"> 1. Check another tap. 2. Straighten the water inlet pipe to smooth water supply. 3. Change the filter cartridge or call the maintenance personnel. 4. Wait for the water to refill.
Hot water does not come out.	<ol style="list-style-type: none"> 1. The water temperature is lower than 90 °C. 2. There is not adequate water. 	<ol style="list-style-type: none"> 1. Wait for the water to be heated to 90 °C. 2. Refer to 'the water shortage indicator shows "--"'.
The hot water is not hot and the temperature does not go up.	<ol style="list-style-type: none"> 1. The "Power Saving" mode is on and the water temperature is limited to 60-65 °C in standby mode. 2. The "Power Saving" mode is on and the water temperature is limited to 60 °C. 3. Inner malfunction. 	<ol style="list-style-type: none"> 1. Turn off the "Power Saving" mode and wait for the temperature to rise. 2. Reset the heat retention temperature. 3. Contact maintenance personnel.

Q&A

Q: What should I do if the display panel does not light up or does not respond?

A: Please check if the power cord is disconnected, or the leakage circuit breaker is not turned on, or the power switch is activated (please refer to the Installation and Operation Manual).

Q: "--" appears on the display panel, how to deal with it?

A: Please check whether the water source is normal and whether the water inlet switch has been turned on.

Q: "E1"~"E8 and EE" appears on the display panel, what should be done?

A: Please turn off the power and call a specialist for repair.

Q: What should be done when the brightness of the display panel is low?

A: Make sure that the power supply is within the standard values (refer to the installation and usage instructions).